



Option  
End-side Cable Installed

# VISION LED STRIP LIGHT

Wide size ideal to replace the two-lamp fluorescent strip



## PRODUCT DESCRIPTION

Above All Lighting's Vision LED strip light has a sleek design with a diffuser lens. Optical accessories include EBU and motion sensor. It can be used in stairwells, warehouses, offices, garages, shop displays, and other commercial applications

## FEATURE

- 8% up-light and no glare
- Quick and Easy to wire and install
- Seamless connection
- Built-in sensor
- EBU backup available
- Ceiling & wall surface mounted, suspension mounted

## ELECTRICAL SYSTEM

- Input Voltage: 120-277V, 120-347V 50/60Hz
- Class 2 driver
- Minimum Ambient -20°C, Maximum Ambient is 40°C
- Power Factor: > 0.9 at full load
- Total Harmonic Distortion: < 20% at full load

## PERFORMANCE

CRI

80

CCT

3000K, 3500K, 4000K, 5000K

Dimming

0-10V Dimming Standard

Projected Lifetime

L70 - 156,000 Hours

Working Temperature

-4-104°F (-20-40°C)

\* Maximum temperature is 95°F (35°C) for 4ft, 90W

Certifications

- cETLus conforms to UL Std. 1598 Cert. to CSA Std. C22.2 No.250.0
- Suitable for damp locations
- DLC Premium<sup>1</sup>
- IK10 Rated
- RoHs compliant

Notes:

1. DLC premium is for 4ft 30W and 45W with frosted lens.

## SPECIFICATION

### 2FT

Net. Weight: 4.5 lbs

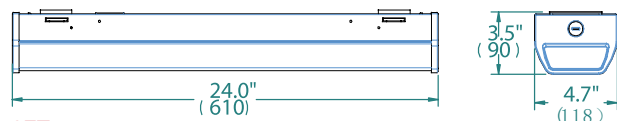

### Option

End-side cable installed

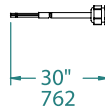

### 3FT

Net. Weight: 5.9 lbs

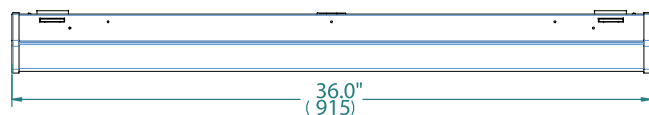

### 4FT

Net. Weight: 7.5 lbs

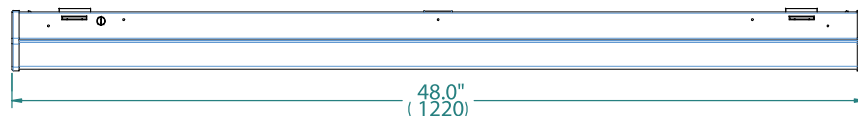

### 8FT

Net. Weight: 13.5 lbs

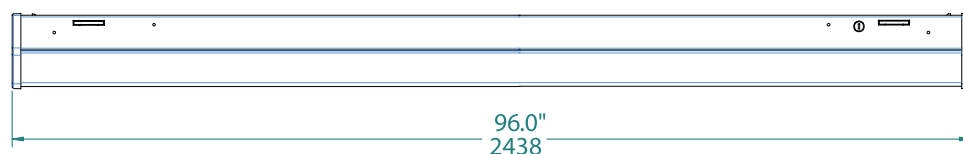

### With Two Reflectors

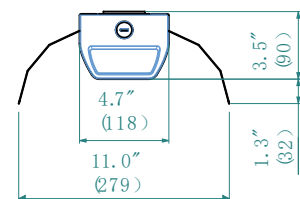

## Ordering Information

### Example: STR12D30LED408F

Strip Fixture	Dimension	Dimmable	Watts	LED	CCT	Voltage	Series	Controls
STR	06 - 2FT	D - 0-10V Dimmable	20 - 20 Watts	LED	30 - 3000K	8 - 120-347V	F-Frosted lens <sup>3</sup>	Blank - None MSW-Microwave Dimming sensor <sup>1</sup> EBU - Emergency Battery Back-up <sup>2</sup>
			26 - 30 Watts		35 - 3500K		C-Clear Lens <sup>3</sup>	
	40 - 4000K							
	09 - 3FT <sup>4</sup>	20 - 20 Watts						
		30 - 30 Watts						
		45 - 45 Watts						
		60 - 60 Watts <sup>5</sup>						
		90 - 90 Watts <sup>5</sup>						
	12 - 4FT	60 - 60 Watts						
		85 - 80 Watts						
24 - 8FT								

### Option



#### 2ESCI

2ft End-side Cable Installed, white, no plug

Note: Standard product does not include the end-side cable. If need end-side cable installed please ask Customer Service.

1. Microwave dimming sensor for mounting height 20ft (6m) max. Dimming default setting is Bi-Level dim, 50% on vacancy and 100% on Occupancy. Daylight sensor default setting is disabled. Orther settings such as ON/OFF function can be set by the remote controller. Please consult with customer service for details.
2. Emergency battery back-up is not available for 4ft @ 60W and 90W. It is for ambient temperatures of 32°F-95°F(0 °C-35°C). The emergency test button is pre- installed on the fixture. The standard emergency test button is plastic. Metal emergency test button is optional. The EBU is Title 20 compliant. Emergency battery backup is available in 8W with 1360lm and works for a minimum of ninety (90) minutes.
3. Frosted lens is standard. Please contact Customer Service for the lead time of clear lens.
4. 3ft is without DLC. Please contact Customer Service for lead time of 3ft vision strip.
5. 4ft @ 60W and 90W are not available for Emergency Battery Back-up.

\* Surface mount is standard. If quick surface mount or V-hook mount is needed, please order the mounting brackets separately . Please check the accessory table for details.

\* MSW can read vibration as movement and trigger the sensor despite no physical movement in the sensor field. As such, MSW should not be installed in rooms that experience significant levels of vibration

\* Standard Finish is White. Custom colors might be available for an additional fee. Please check with Customer Service for more information.

## Accessories (Ordered separately)



**90237**

STRP06-WG

Wire guard for 2ftstrip

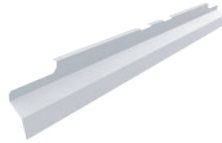

**90238**

STRP12-WG<sup>1</sup>

Wire guard for 4ft and  
8ft strip



**90243**

STRP-VH<sup>4</sup>

V-hooks for strip

**90240**

STRP06-RF

Reflector 2ft strip

**90242**

STRP12-RF<sup>2</sup>

Reflector 4ft and  
8ft strip



**90264**

STRP-QSMK<sup>3</sup>

Quick surface mount kit for  
ceiling and wall mount (a pair)



**90759**

STR-PMK

Pendant Mount Kits for strip (a pair)



**90576**

MH10

Remote control for MSW

### Notes:

1. If for 8ft please order two pieces.
2. If this reflector will be installed at one side, then one piece for 4ft and two pieces for 8ft. If this reflector will be installed at both two sides, then two pieces for 4ft and four pieces for 8ft.
3. Two pieces are needed for 2ft, 3ft and 4ft . If for 8ft please order three pieces.
4. Soft chain mount with V-hooks is the best choice if fixture is with MSW or MSWO and needed to be installed on a ceiling of long time vibration.

## PHOTOMETRY

All published luminaire photometric testing performed to IESNA LM-79-08 standards by a NVLAP certified laboratory.

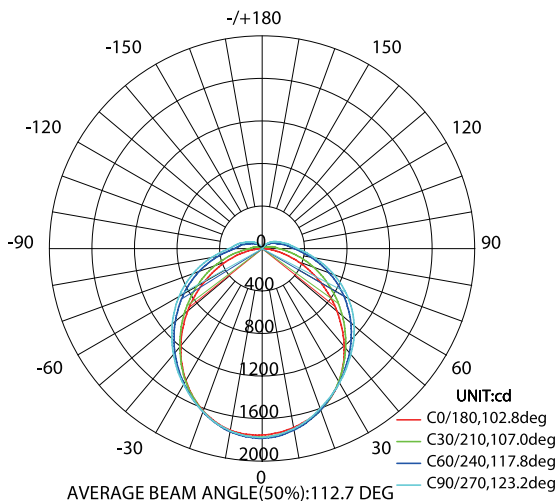

## PERFORMANCE DATA

### LUMEN OUTPUT

Lumen values are estimated with LED data sheet.

#### Frosted Lens

Watts	Lumen Output	Measured Watts	Size	CRI	AC Input 120V	CCT	LPW
20	3000	20	2FT	80	0.18A	5000K	150
30	4500	30	3FT	80	0.24A	5000k	150
20	3000	20	4FT	80	0.18A	5000K	150
30	4500	30	4FT	80	0.28A	5000K	150
45	6900	46	4FT	80	0.41A	5000K	150
60	9000	60	4FT	80	0.50A	5000K	150
90	14000	92	4FT	80	0.77A	5000K	152
60	9000	60	8FT	80	0.50A	5000K	150
85	11600	80	8FT	80	0.67A	5000K	145

#### Clear Lens

Watts	Lumen Output	Measured Watts	Size	CRI	AC Input 120V	CCT	LPW
20	3160	20	2FT	80	0.18A	5000K	158
30	4740	30	3FT	80	0.24A	5000K	158
20	3160	20	4FT	80	0.18A	5000K	158
30	4740	30	4FT	80	0.28A	5000K	158
45	7268	46	4FT	80	0.41A	5000K	158
60	9480	60	4FT	80	0.50A	5000K	158
90	14500	92	4FT	80	0.77A	5000K	158
60	9480	60	8FT	80	0.50A	5000K	158
85	12240	80	8FT	80	0.67A	5000K	153

#### Lumen Ambient Temperature (LAT) Multipliers

Use these factors to determine relative lumen output for average ambient temperature from -4-104°F (-20-40°C)

Ambient		Multiplier
Celsius	Fahrenheit	
0	32	1.06
10	50	1.03
20	68	1.01
25	77	1.00
30	86	0.99
40	104	0.97

#### Projected LED Lumen Maintenance

Data references the extrapolated performance projections for the LED strip in a 77°F ambient, (tested per IESNA LM-80-08 and projected per IESNA TM-21-11).

Operating Hours	10,000	19,000	38,000	156,000
Lumen Maintenance Factor	0.98(L98)	0.96(L96)	0.92(L92)	0.70(L70)

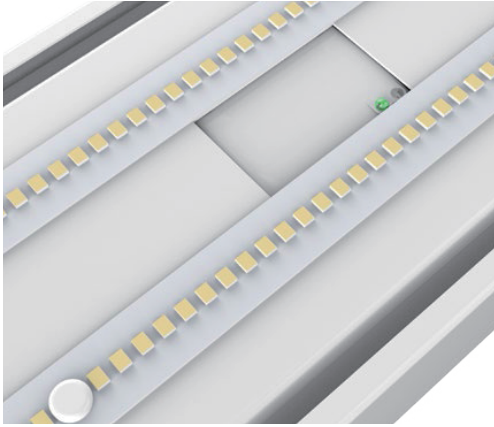

- **Built-in** sensor



- **Easy to wire** end and back side wire entries available, meet different junction box locations.



- **EBU** backup available  
The standard emergency test button is plastic. Metal emergency test button is optional

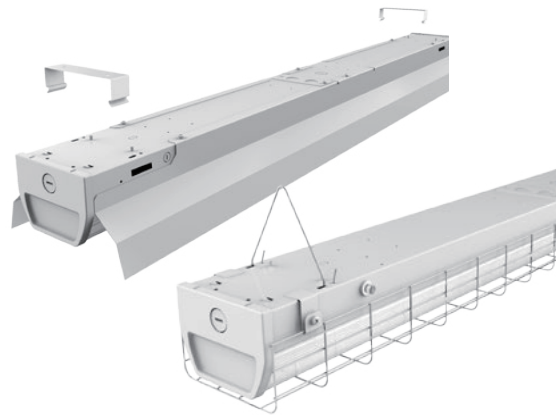

- **Easy to install** quick ceiling & wall surface mount and V-hook mount optional, no need to open the housing.

## MICROWAVE DIMMING SENSOR

### DIMMING FUNCTION

#### 3-step dimming function

The sensor is an innovative motion sensor, switch on the light on detection of movement, and switch off after a hold time when there is no motion detected.

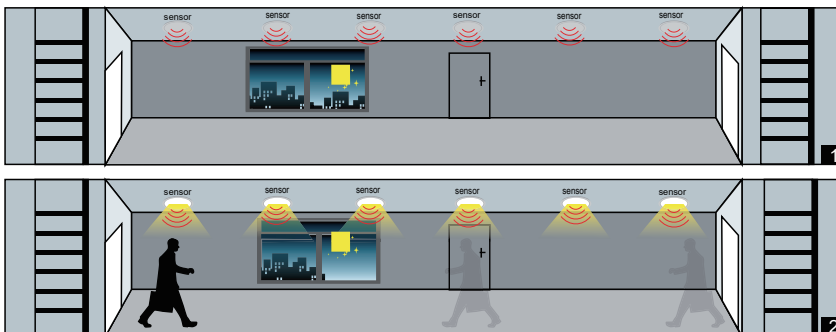

1. No motion detected, all lamps switch off.

2. Any movement is detected from any direction, all lamps synchronously switch on.

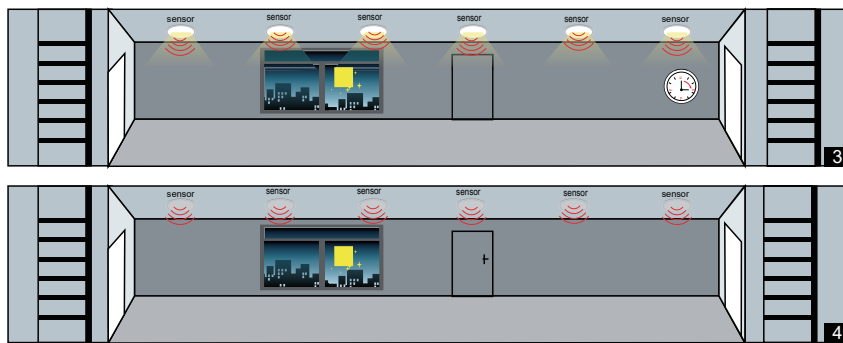

3. No motion is detected in detection area, all lamps synchronously dim to a low light level after hold time.
4. After stand-by period, the lamps switch off if no movement is detected in the detection zone.

## MICROWAVE DIMMING SENSOR SETTING

Sensor data can be precisely set for each specific application by a remote controller which need to be bought separately.

### Detection area

Detection area can be reduced by selecting the combination on the remote controller to fit precisely each application.

Optional Setting: 100%/75%/50%/25%

**Default Setting: 100%**

### Hold time

Refers to the time period the lamp remains at 100% illumination after no motion detected.

Optional Setting: 5S/30S/1min/3min/5min/10min/20min/30min

**Default Setting: 20min**

### Stand-by period

Refers to the time period the lamp remains at a low light level before it completely switches off in the long absence of people. When set to “+∞” mode, the low light is maintained until motion is detected.

Optional Setting: 0S/10S/1min/3min/5min/10min/30min/+∞

**Default Setting: +∞**

Notes: If just need ON/OFF function, please set the stand-by period in “0S” mode by the remote controller.

### Daylight sensor

The sensor can be set to only allow the lamp to illuminate below a defined ambient brightness threshold. When set to Disable mode, the daylight sensor will switch on the lamp when motion is detected regardless of ambient light level. 50lux, 30lux: twilight operation, 10lux, 5lux: darkness operation only. Note that daylight sensor is active only when lamp totally switches off.

Optional Setting: 5lux/15lux/30lux/50lux/100lux/150lux/Disable

**Default Setting: Disable**

### Stand-by dimming level

The low light level you would like to have after the hold time in the long absence of people.

Optional Setting: 10%/20%/30%/50%

**Default Setting: 50%**

## Warranty

Five year limited warranty. Full warranty terms located at [www.aboveallighting.com/warrantystatements](http://www.aboveallighting.com/warrantystatements)

Please refers to the instruction manual for motion sensor default setting.