

MAGNETIC TRACK PROFILE RECESSED WITH FLANGE

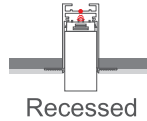

PRODUCT DESCRIPTION

This magnetic track is Recessed with Flange. It isn't just about track rail, it's also about creating unique lighting configurations. Thanks to different types of corners, the geometrical possibilities really are endless. Light components, ranging from linear, wall washer to adjustable spotlights and decorative pendants snap in the track magnetically, without tools. Standard length is available in 1, 2 & 3 meter sections.

GENERAL SPECIFICATION

Material	Aluminum
Color	RAL9004 Black/RAL 9003 White
Input Voltage	24Vdc
Input Current	8A Max

DIMENSION

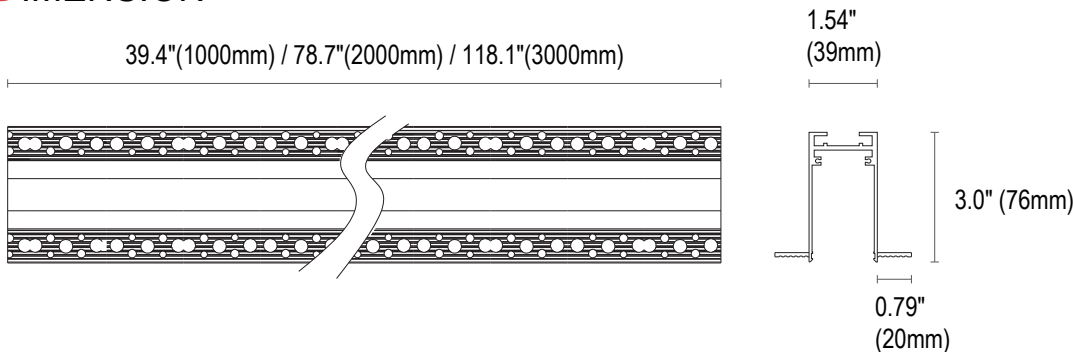

Ordering Information

Example: MTS-RF-1M-24V-BK

Series	Length ¹	- Voltage	Installation	- Frame Finish
MTS-RF -Magnetic Track Profile Recessed with Flange	1M -39"	- 24V-24Vdc ²	Blank - Recessed with flange	- BK -Black ³
	2M -79"			Optional
	3M -118"			WH -White ³

Notice:

1. Custom track length is optional. If for special track length and pattern demand, please contact Customer Service. Continuous run mount can't exceed 50 meters, otherwise voltage drop will occur.
2. 24V constant voltage LED drivers can be chosen in the following driver list or supplied by customer. The total fixture wattages can't exceed 300W.
3. Black finish is standard. Custom color is available for a premium setup fee. Consult customer service for additional information.

ACCESSORIES (ORDER AND SHIP SEPARATELY)

CORNER

L Corner

■ Sandy Black □ Sandy White

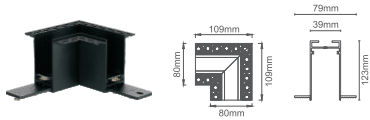

MTS-RF-LC-BK

Inner Corner

■ Sandy Black □ Sandy White

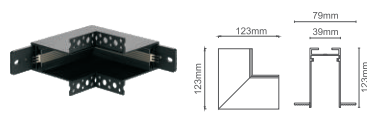

MTS-RF-IC-BK

Cross Corner

■ Sandy Black □ Sandy White

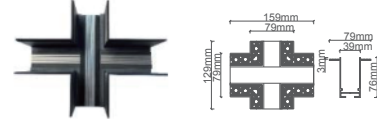

MTS-RF-CC-BK

T Corner

■ Sandy Black □ Sandy White

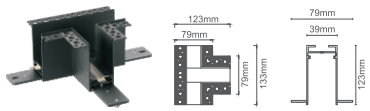

MTS-RF-TC-BK

Outer Corner

■ Sandy Black □ Sandy White

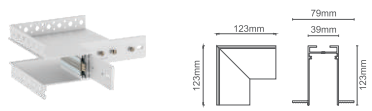

MTS-RF-OC-BK

MOUNTING

Track connector

■ Sandy Black □ Sandy White



MTS-CNCT-BK

Track cover

■ Sandy Black □ Sandy White



MTS-RF-COVER-BK

Driver box

■ Sandy Black □ Sandy White

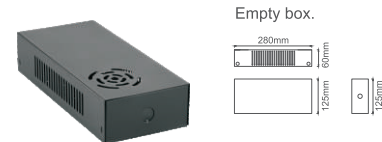

MTS-DBOX-BK

Track bridge

■ Sandy Black □ Sandy White



Current:Max 8A,Power:Max 200W

MTS-TB-BK

CONSTANT VOLTAGE LED DRIVER LIST (ORDER AND SHIP SEPARATELY)

NON-DIMMABLE LED DRIVER

75W

XLG-75-24-A

 75W, non-dimmable
 Size: 180x63x35.5mm
 input voltage: AC100-305V,
 output voltage: 24V DC

100W

XLG-100-24-A

 100W, non-dimmable
 Size: 180x63x35.5mm
 input voltage: AC100-305V,
 output voltage: 24V DC

150W

XLG-150-24-A

 150W, non-dimmable
 Size: 180x63x35.5mm
 input voltage: AC100-305V,
 output voltage: 24V DC

200W

XLG-200-24-A

 200W, non-dimmable
 Size: 180x63x35.5mm
 input voltage: AC100-305V,
 output voltage: 24V DC

5 IN 1 DIMMABLE LED DRIVER

80W

KVG-24080-DWJ

 80W, Triac/0-10V/1-10V/10V PWM
 input voltage: 120-277V
 output voltage: 24V DC

100W

KVG-24100-DWJ

 100W, Triac/0-10V/1-10V/10V PWM
 input voltage: 120-277V
 output voltage: 24V DC

150W

KVG-24150-DWJ

 150W, Triac/0-10V/1-10V/10V PWM
 input voltage: 120-277V
 output voltage: 24V DC

200W

KVG-24200-DWJ

 200W, Triac/0-10V/1-10V/10V PWM
 input voltage: 120-277V
 output voltage: 24V DC

300W

KVG-24300-DWJ

 300W, Triac/0-10V/1-10V/10V PWM
 input voltage: 120-277V
 output voltage: 24V DC

DALI INTELLIGENT LED DRIVER

100W

LM-100-24-G1D2

 100W, DALI-2, Push DIM
 Size: 352x43x30mm(LxWxH)
 input voltage: AC120-277V,
 output voltage: 24V DC

Warranty

Five year limited warranty.

Working temperature: -20°C to + 40°C(-4 °F to 104°F)

Specifications subject to change without notice.