



VISS SQUARE LED LIGHT

Acoustic Available



PRODUCT DESCRIPTION

The Viss Series has an unique square and round style with an LED light source illuminating its inner surface. It is available in sizes ranging from 14.2" up to 31.5". Deep recessed light source design achieving perfect glare control. Flexible installations come in suspended and surface mount. Working harmoniously with acoustic materials to reduce the noise-levels in any space. Maximizes surface area to absorb sound waves and improve harmony in the installed space.

FEATURE

- Available in standard light and acoustic w/light.
- Illuminating from the inner surface
- Suspended and surface mounted
- 30+ acoustic felt colors available

ELECTRICAL SYSTEM

- Input Voltage: 120-277V, 50/60Hz
- 0-10V Dimming standard
- Minimum Ambient -20°C, Maximum Ambient is 40°C
- Power Factor: > 0.9 at full load
- Total Harmonic Distortion: < 20% at full load

SPECIFICATION

Aircraft Cable and Wire Cord Length: 59"(1500mm)

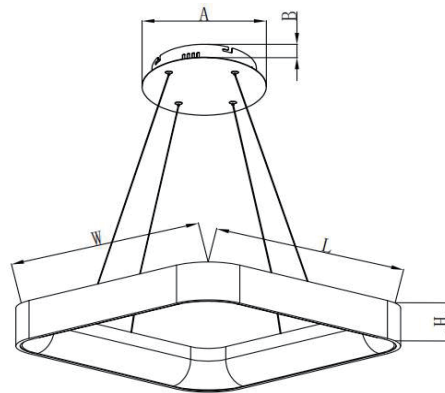

Aircraft Cable Suspended Mount

PERFORMANCE

CRI

90

CCT

3000K, 3500K, 4000K

Dimming

0-10V Dimming Standard

Projected Lifetime

L70 - 100,000 Hours

Working Temperature

-4-104°F (-20-40°C)

Certifications

- cETLus conforms to UL Std. 1598 Cert. to CSA Std. C22.2 No.250.0
- Suitable for damp locations
- RoHs compliant

Model No	L	W	H	A	B	Dimension Code
15W	14.2"(360mm)	14.2"(360mm)	3.5"(88mm)	10.0"(250mm)	2.0"(50mm)	14*14
25W	17.7"(450mm)	17.7"(450mm)	3.5"(88mm)	10.0"(250mm)	2.0"(50mm)	18*18
36W	23.6"(600mm)	23.6"(600mm)	3.5"(88mm)	10.0"(250mm)	2.0"(50mm)	24*24
50W	31.5"(800mm)	31.5"(800mm)	3.5"(88mm)	10.0"(250mm)	2.0"(50mm)	32*32

Surface Mount

Model No	L	W	H	Dimension Code
15W	14.2"(360mm)	14.2"(360mm)	4.6"(115mm)	14*14
25W	17.7"(450mm)	17.7"(450mm)	4.6"(115mm)	18*18
36W	23.6"(600mm)	23.6"(600mm)	4.6"(115mm)	24*24
50W	31.5"(800mm)	31.5"(800mm)	4.6"(115mm)	32*32

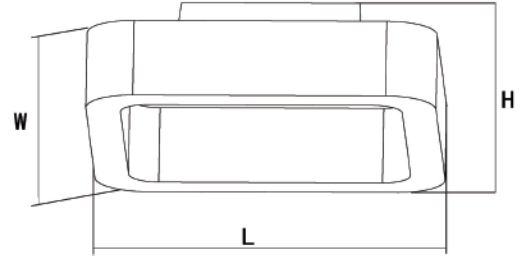

Ordering Information

Example: VS I - S - LA - 3624 - 40 90 1 - ACPMK - / - WH - NSAC-021 130

1 2 3 4 5 6 7 8 9 10 11 12

1. Series

VS - Viss series

2. Light Emitting

I - Inward Light

3. Shape

S - Square

4. Acoustic Configuration

Blank- Light without Acoustic **LA** - Light with Acoustic

* If choose Acoustic, please choose the acoustic color in the following list.

5. Watts/Size

1514 - 15W/14.2"x14.2" **3624** - 36W/23.6"x23.6"
 2518 - 25W/17.7"x17.7" **5032** - 50W/31.5"x31.5"

6. CCT

30 - 3000K **35** - 3500K **40** - 4000K

7. CRI

90 - 90Ra

8. Voltage

1 - 120-277V

9. Installation

ACPMK - Aircraft Cable Suspended Mount Kits **SMK** - Surface Mount Kits

10. Controls

Blank - None

11. Frame Finish

WH - White **BK** - Black

12. Acoustic Color



* There will be slight differences between the color of the acoustic image and the actual fabric because of computer display defects.

* The standard acoustic colors include: NSAC-021 130, NSAC-042 146, NSAC-028 110, NSAC-002 122, NSAC-033 103. Other acoustic colors might be available for an additional fee. Please check with Customer Service for more information.

PHOTOMETRY

All published luminaire photo metric testing performed to IESNA LM-79-08 standards by a NVLAP certified laboratory. IESNA LM -79-08 specifies the entire luminaire as the source resulting in a fixture efficiency of 100%. Result may vary per actual order.

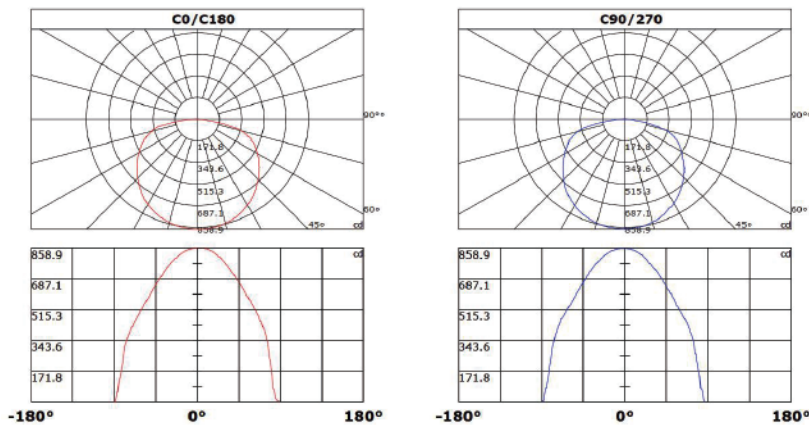

PERFORMANCE DATA

LUMEN OUTPUT

Watts	Lumen Output	AC Input 120V	CCT	CRI	LPW
15	1280	0.13A	4000K	90	70
25	2100	0.21A	4000K	90	70
36	3000	0.30A	4000K	90	70
50	4300	0.42A	4000K	90	70

Note:

1. The lumen output is for the fixture without acoustic. The data for acoustic may vary based on different acoustic fiber colors. Please contact Customer Service if need the lumen output for acoustic version.

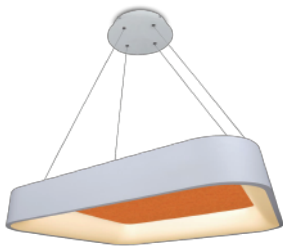

Pendant Mount with Acoustic

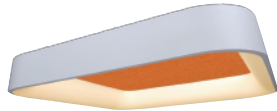

Surface Mount with Acoustic

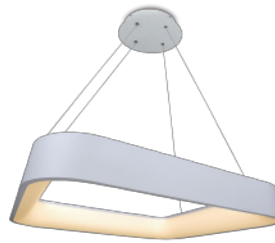

Pendant Mount without Acoustic

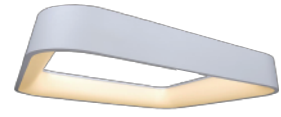

Surface Mount without Acoustic

Warranty

Five year limited warranty.

Specifications subject to change without notice.