



# MELO CYLINDER PENDANT LIGHT



## PRODUCT DESCRIPTION

The MELO cylinder would greatly create possibilities in the whole commercial area. Multiple sizes, beam options, and high visual comfort COB LED. It is now available in pendant and surface mount configurations which offers a beautiful and architectural cylinder solutions.

## FEATURES

- Modular design
- COB LED chip: 80+ standard, 90+ optional
- Dimming: 0-10V(10% standard, 1% optional) or TRIAC
- Beam angle: 15°, 24°, 36°, 60° options
- Architectural form : 4", 6" and 8"
- Mounting: Pendant or surface
- Wattage Selectable

## ELECTRICAL SYSTEM

- Input Voltage: 120-277V, 50/60Hz
- Operating temperature range: -4-77°F (-20-25°C)
- Power Factor: > 0.9 at full load
- Total Harmonic Distortion: < 20% at full load

## PERFORMANCE

CRI

80

CCT

3000K, 3500K, 4000K

Dimming

0-10V(10% standard, 1% optional)  
 TRIAC dimming optional

Projected Lifetime

L70 - 100,000 Hours

Working Temperature

-4-77°F (-20-25°C)

Certifications

- cULus conforms to UL Std. 1598Cert. to CSA Std. C22.2 No.250.0
- Suitable for damp locations
- RoHS compliant

## CANOPY OPTIONS

### Flat Canopy For Recessed J-box

If J-box is recessed (3" octagon, 4" octagon and 4" round), a 4.5" flat canopy is provided for mounting to recessed junction box in white or black powder coat painted finish.

### Conduit Deep Canopy For Surface Mount J-box

If standard 4" octagonal J-box is surface mounted, a Ø5.97" round x 2.38" deep canopy with conduit cutout is provided for mounting. Conduit cutout canopy has 4 key slots, one in each side, and can be configured to accommodate any ceiling layout using 1/2" or 3/8" conduit. Conduit cutout canopy is provided white and black powder coat painted finish.

### Conduit Mounting Example

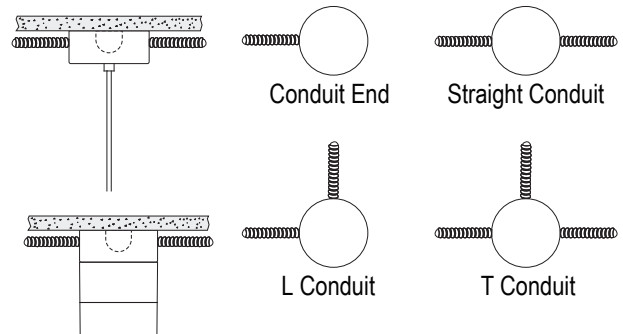

## MOUNTING

### Cable Pendant Mount

White/black cable is provided in length specified ( 4' standard ). Installers can cut the cable in the field to desired length.

Notes:

- For 4", the cable and aircraft cable is combined in one pipe.
- For 6" and 8", the cable and aircraft cable are separated.

### Stem Pendant Mount

Ø12/25" steel stem is provided in length specified ( 4' standard) and is provided in white or black finish.

### Surface Mount

Surface mount to recessed or surface mounted junction box.

#### For Recessed J-box



Cable Pendant 4"    Cable Pendant 6" / 8"    Stem Pendant 4" / 6" / 8"

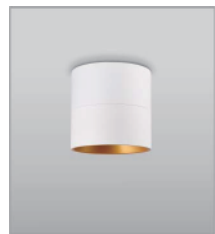

4" / 6" / 8" Surface Mount

#### For Surface Mount J-box



Cable Pendant 4"    Cable Pendant 6" / 8"    Stem Pendant 4" / 6" / 8"



4" Surface Mount



6" Surface Mount



8" Surface Mount

## EMERGENCY OPTIONS

Optional high voltage 8W emergency LED driver EM-H08170-LBF can be provided. When AC power fails it immediately , switches to the emergency mode, operating for lighting up to 120 minutes. When AC power is restored, it automatically returns to the charging mode which meets critical life-safety lighting requirements.

For more info or spec sheet, please visit our website or contact sales.

### Emergency Lumen Output:

Fixture Efficacy	Output Power 8w
80lm/w	640 Lumens

### Canopy With Indicator



## Ordering Information

**E**xample: MELO04R-SP30901-10D-36-WH-WH

MELO	04	R	SP	30	90	1	10D
1	2	3	4	5	6	7	8

36	WH	WH
9	10	11

### 1. Series

- MELO

### 2. Size

- 04 - 4inch       06 - 6inch       08 - 8inch

### 3. Shape

- R - Round

### 4. Power

- SP - Wattage Selectable  
 25W/18W/12W for 4inch  
 40W/30W/20W for 6inch  
 58W/44W/29W for 8inch

### 5. CCT

- 27 - 2700K       30 - 3000K  
 35 - 3500K       40 - 4000K

### 6. CRI

- 80 - 80+ CRI (Standard)       90 - 90+ CRI (Optional)

### 7. Voltage

- 1 - 120-277V

### 8. Dimming Options

- 10D - Dims to 10% (Standard)       01D - Dim to 1% (Optional)
- TRD - TRIAC Dimming (Optional)

### 9. Beam Angle

- 15 - 15°       24 - 24°  
 36 - 36°       60 - 60°

### 10. Baffle

- WH - White       BK - Black  
 GD - Golden       CM - Chrome



### 11. Finish

- WH - White       BK - Black

\* White and black finish are standard. Custom color is available for a premium setup fee. Consult customer service for additional information.

### Installation (ordered separately)

#### FOR RECESSED JUNCTION BOX

- Surface Mount       Aircraft cable pendant Mount  
 Rigid stem pendant Mount

#### FOR SURFACE MOUNTED JUNCTION BOX

- Surface Mount       Aircraft cable pendant Mount  
 Rigid stem pendant Mount

\* Please choose the desired mounting accessories in the following accessory table.

## Accessories (ordered separately and field installed)

### FOR RECESSED JUNCTION BOX

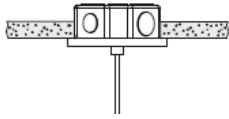

**MELO-PMK-AC-RM-4-4FT-WH**

Aircraft cable mount for 4" MELO, 4ft long cable, white (recessed junction box)

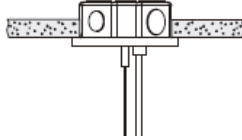

**MELO-PMK-AC-RM-6-4FT-WH**

Aircraft cable mount for 6" MELO, 4ft long cable, white (recessed junction box)

**MELO-PMK-AC-RM-8-4FT-WH**

Aircraft cable mount for 8" MELO, 4ft long cable, white (recessed junction box)

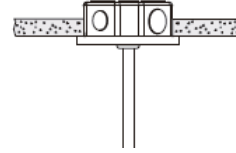

**MELO-PMK-RS-RM-4-4FT-WH**

Rigid stem mount for 4" MELO, 4ft long stem, white (recessed junction box)

**MELO-PMK-RS-RM-6-4FT-WH**

Rigid stem mount for 6" MELO, 4ft long stem, white (recessed junction box)

**MELO-PMK-RS-RM-8-4FT-WH**

Rigid stem mount for 8" MELO, 4ft long stem, white (recessed junction box)



**MELO-SMK-SM-RM-4-WH**

Surface mount for 4" MELO, white (recessed junction box)

**MELO-SMK-SM-RM-6-WH**

Surface mount for 6" MELO, white (recessed junction box)

**MELO-SMK-SM-RM-8-WH**

Surface mount for 8" MELO, white (recessed junction box)

## FOR SURFACE MOUNTED JUNCTION BOX

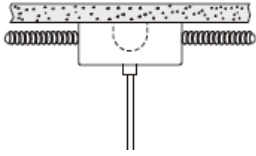

**MELO-PMK-AC-SM-4-4FT-WH**

Aircraft cable mount for 4"  
MELO, 4ft long cable, white  
(surface mounted junction box)

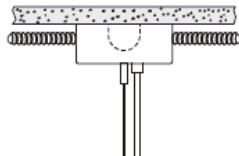

**MELO-PMK-AC-SM-6-4FT-WH**

Aircraft cable mount for 6"  
MELO, 4ft long cable, white  
(surface mounted junction box)

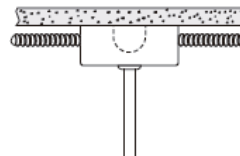

**MELO-PMK-RS-SM-4-4FT-WH**

Rigid stem mount for 4"  
MELO, 4ft long stem, white  
(surface mounted junction box)

**MELO-PMK-AC-SM-8-4FT-WH**

Aircraft cable mount for 8"  
MELO, 4ft long cable, white  
(surface mounted junction box)

**MELO-PMK-RS-SM-6-4FT-WH**

Rigid stem mount for 6"  
MELO, 4ft long stem, white  
(surface mounted junction box)

**MELO-PMK-RS-SM-8-4FT-WH**

Rigid stem mount for 8"  
MELO, 4ft long stem, white  
(surface mounted junction box)



**MELO-SMK-SM-SM-4-WH**

Surface mount for 4" MELO, white  
(surface mounted junction box)

**MELO-SMK-SM-SM-6-WH**

Surface mount for 6" MELO, white  
(surface mounted junction box)

**MELO-SMK-SM-SM-8-WH**

Surface mount for 8" MELO, white  
(surface mounted junction box)



**EBU-H08170**

8W Emergency Battery  
Back-up (ordered separately  
and field installed)

\* Emergency battery back-up is for ambient temperatures of 32°F -77°F (0 °C -25°C ).

## DIMENSIONS

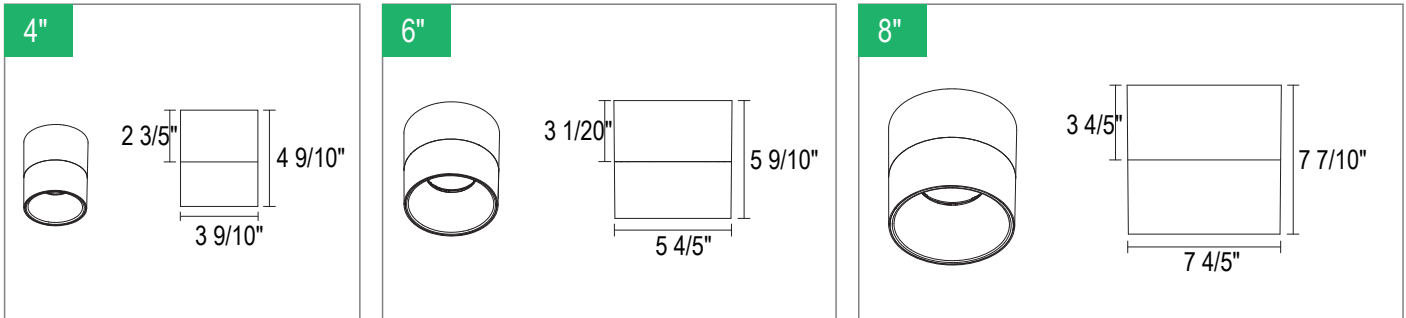

### For use with recessed J-boxes

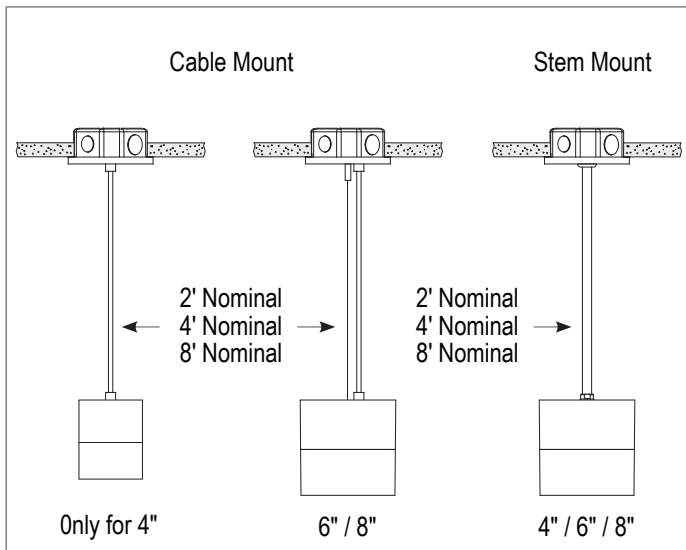

### For use with surface mounted J-boxes

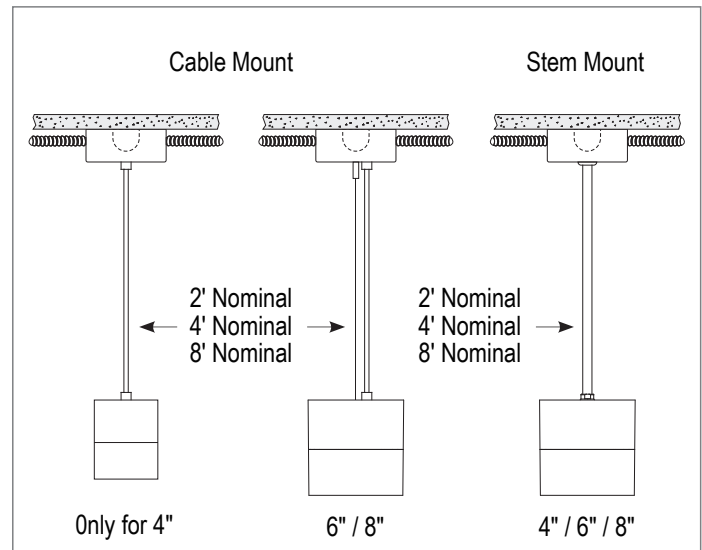

## PHOTOMETRY

All published luminaire photo metric testing performed to IESNA LM-79-08 standards by a NVLAP certified laboratory. IESNA LM-79-08 specifies the entire luminaire as the source resulting in a fixture efficiency of 100%. Result may vary per actual order.

### 4" / 3000K / 60°

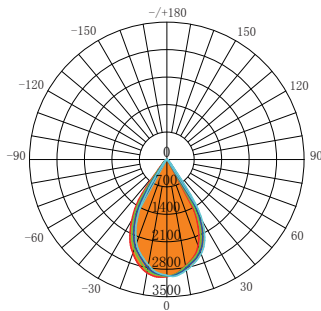

AVERAGE BEAM ANGLE (50%): 61.0 °  
 Lumens: 2612.6 Lm      UNIT :cd  
 Watts: 25 W      — C0 /180, 61.0°  
 LPW: 103.94 Lm/W      — C30 /210, 61.1°  
 CCT: 3000K      — C60 /240, 61.1°  
                              — C90 /270, 60.7°

### 6" / 3000K / 60°

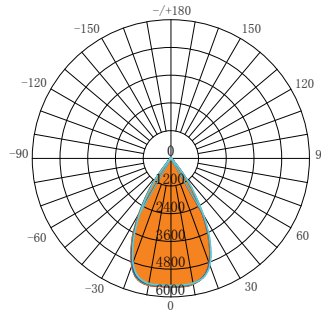

AVERAGE BEAM ANGLE (50%): 59.6 °  
 Lumens: 5046.4 Lm      UNIT :cd  
 Watts: 45 W      — C0 /180, 59.5°  
 LPW: 111.38 Lm/W      — C30 /210, 59.5°  
 CCT: 3000K      — C60 /240, 59.6°  
                              — C90 /270, 59.6°

### 8" / 3000K / 60°

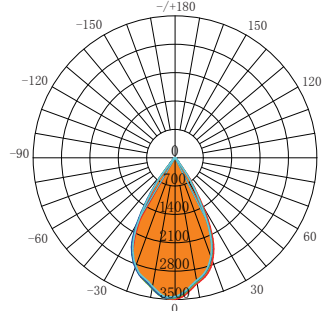

AVERAGE BEAM ANGLE (50%): 57.7 °  
 Lumens: 6000.6 Lm      UNIT :cd  
 Watts: 60 W      — C0 /180, 57.5°  
 LPW: 95.85 Lm/W      — C30 /210, 57.8°  
 CCT: 3000K      — C60 /240, 58.0°  
                              — C90 /270, 57.5°

## PERFORMANCE DATA

Lumen values are measured by third party certified laboratories performed in accordance with IESNA LM-79-08 as well as Lighting Facts listed.

Diameters	4inch/6inch/8inch
Wattage	25W/18W/12W for 4inch 40W/30W/20W for 6inch 58W/44W/29W for 8inch
Voltage	120-277V
Efficacy @3000K	2600lm@25W 4200lm@40W 6000lm@58W
Installation	Pendant / Surface Mount
Controls (optional)	Emergency Battery Back-up

## Warranty

Five year limited warranty.

## Note:

Specifications subject to change without notice.