

INTRODUCTION



MC087D RC



MH10

PARAMETER

Input	DC Input Voltage	12±1V DC
	Rated Voltage	12±0.6V DC
	Stand-by Power	<0.5W
Output	Working Mode	5V high and low voltage signal, 0-10v signal
Sensor Parameters	Operating Frequency	5.8 GHz ±75 MHz , ISM Band.
	Transmitting power	0.5mW Max.
	Hold time	5S/30S/1min/3min/5min/10min/20min/30min
	Stand-by DIM Level	10%(1.4-1.6V), 20%(1.9-2.1V), 30%(2.9-3.1V), 50% (4.9-5.1V)
	Twilight Time	0s/10S/1min/3min/5min/10min/30min/+∞
	Detection Area	25%/50%/75%/100%
	Daylight Sensor	5lux/15Lux/30Lux/50Lux/100lux/150lux/Disable Daylight priority: ON / OFF value (5lux/15Lux/30Lux/50Lux)/150Lux 100Lux/200Lux 150Lux/300Lux
	Detecting Radius	≥4m (mounting height 3m , moving speed 0.3m/s)
	Mounting Height	6m Max
	Detecting Angle	150°
Operating Environment	Operating Temperature	-20°C...+60°C
	Storage Temperature	Temperature: -40°C...+80°C; Humidity: 10%-95% (non-condensing)
	EMC standards	EN55015, EN61000-3-2, EN61000-3-3, EN61547
	Environmental Requirement	Compliant to RoHS
	Certificate	N/A

Others	Wiring	3 pin 2.0mm fast connector
	IP Rating	IP20
	Protection Class	Class II
	Installation	Base installation
	Dimension	See dimension
	Package	cartons
	Net Weight	18g
	Lifetime	50,000h @ Ta Full load

Note

1. "N/A" means not available.
2. Detection area is effected on volume of motion object and motion speed. The detection area is tested by a 165cm height person and walking speed is 0.5m/s.

FUNCTION

1) On/OFF Function (stand-by period be set to "0"s)

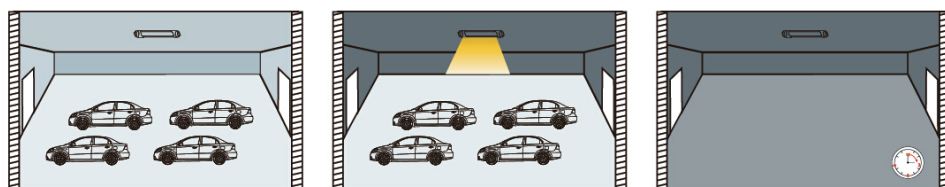

- 1 With sufficient ambient light, the light will not be switched on even if with motion signal.
- 2 With insufficient ambient light, the sensor switches on the light when motion is detected.
- 3 After elapse of hold time, the sensor switches off the light when no motion is detected.

2) 2-step dimming function (stand-by period be set to "+∞")

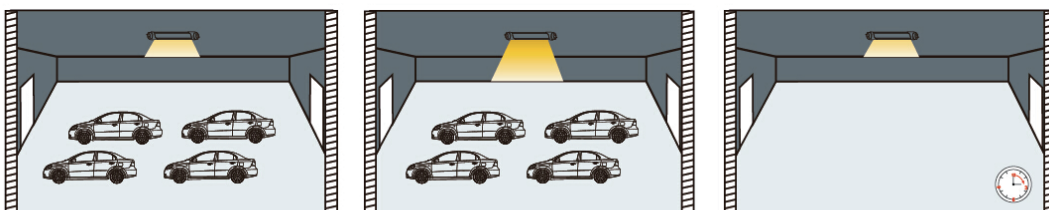

- 1 If there is no motion detected, the light will be remained at a low light level all the time.
- 2 When motion is detected, the sensor will switch on the light to 100% brightness
- 3 After elapse of hold time, the sensor dims the light at the present low light level if no motion is detected.

3) 3-step dimming function (stand-by period be set to "10S/1min/3min/5min/10min/30min")

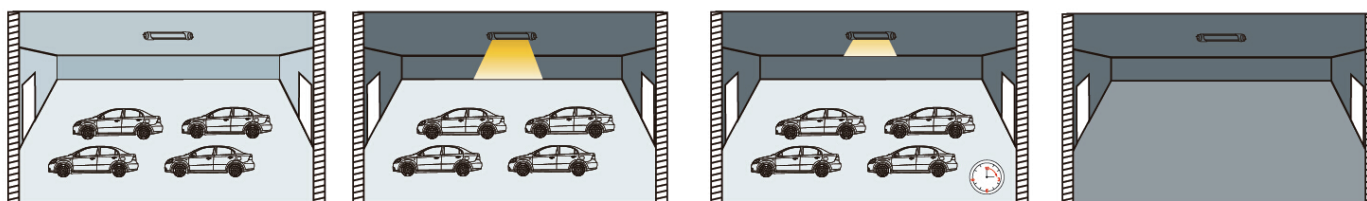

- 1 With sufficient ambient light, the light will not be switched on even if with motion signal.
- 2 With insufficient ambient light, the sensor switches on the light when motion is detected.
- 3 After elapse of hold time, the sensor dims the light at a low light level if no new motion is detected.
- 4 After elapse of standby period, the sensor switches off the light if no motion is detected in the detection zone.

STRUCTURE

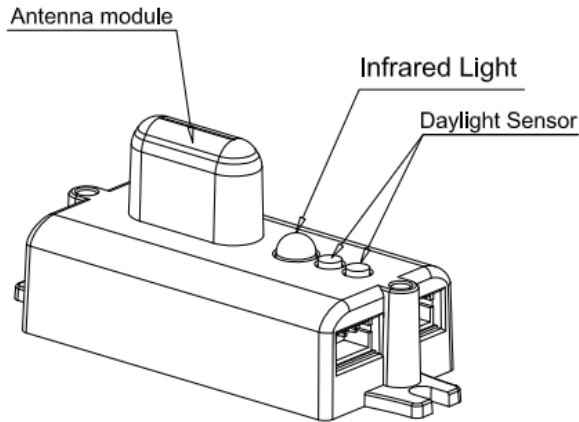

WIRING

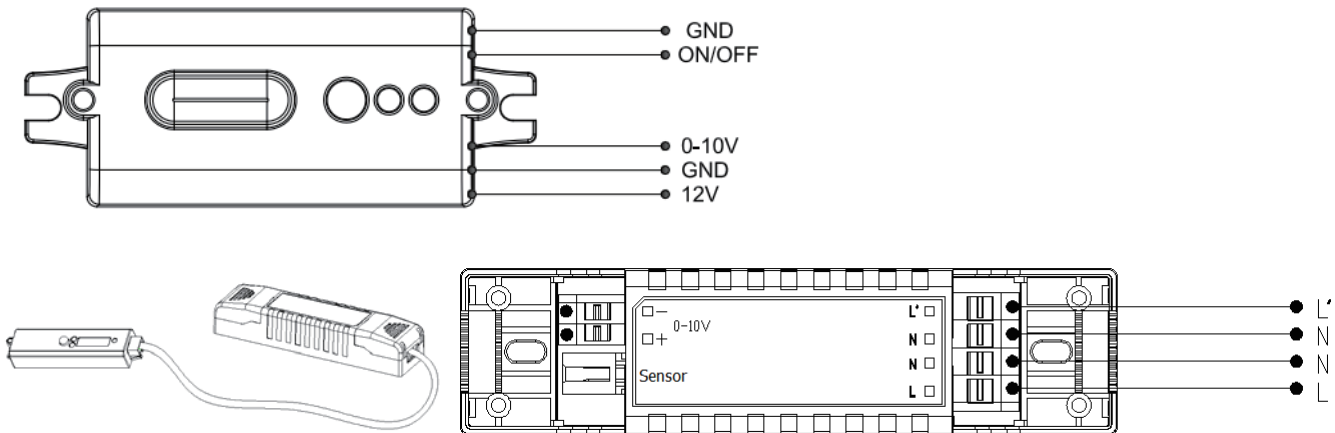

*The sensor is designed for connect one load only. Connect more than one loads may damage the sensor.

DETECTION PATTERN

Ceiling mounting

Ceiling mounted height: 3m
 Sensitivity: 100%/75%/50%/25%

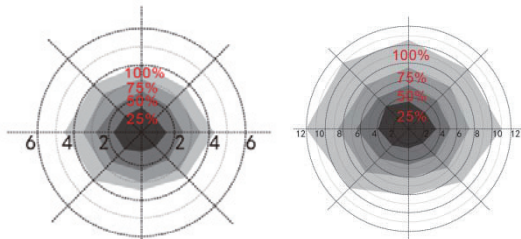

Normal moving
 (Speed:1m/s)

Slow moving
 (Speed 0.3m/s)

Ceiling mounted height: 4m
 Sensitivity: 100%/75%

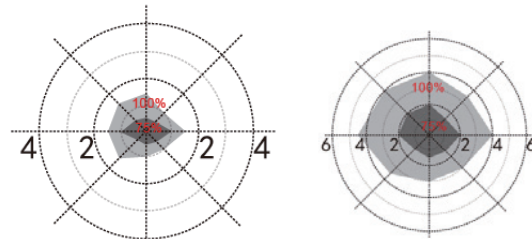

















Normal moving
 (Speed:1m/s)

Slow moving
 (Speed 0.3m/s)

*Only 100% detection sensitivity is workable when installed at 4m mounting height. 25% /50% sensitivity is not able to detect motion signal.

REMOTE CONTROL (order separately)

Remote Control Setting	Button	Remarks																												
	ON/OFF	Press the "ON/OFF" button, the light goes to constant on/off mode, sensor is disabled, Press "Reset" "Auto mode" button to quit from this mode and the sensor starts to work.																												
	Reset	Press "Reset" button, all parameters are same as setting of DIP switch or factory settings.																												
	Sensor motion	Press "Sensor motion" button, the light quits from the constant on/ off mode, and the sensor starts to work (The latest setting stays in validity)																												
	DIM Test	Press "DIM Test" button, the 1-10 V dimming works to test whether the 1-10Vdc dimming ports are connected properly. After 2s, it returns to the latest setting automatically.																												
	Dvverride DH	Long press 3s, Daylight priority mode will be switched to daylight threshold mode, lux value will go back to previous one.																												
	DIM+ DIM-	Short press "DIM+/DIM-" button to Set the output lumen level, each press will will $\pm 2\%$ light level																												
	DH Mode	Long press >3s, sensor will be switched to daylight priority mode; if preset daylight value is Disable, press DH Mode can not start daylight priority mode.																												
	Q1 Q2 Q3	<table border="1"> <thead> <tr> <th>Scene Options</th> <th>Detection Area</th> <th>Hold Time</th> <th>Stand-by period</th> <th>Stand-by dim level</th> <th>Daylight Sensor</th> <th>Induction model</th> </tr> </thead> <tbody> <tr> <td>QS1</td> <td>100%</td> <td>5min</td> <td>10min</td> <td>10%</td> <td>30Lux</td> <td>Hs</td> </tr> <tr> <td>QS2</td> <td>100%</td> <td>10min</td> <td>30min</td> <td>10%</td> <td>Disable</td> <td>Hs</td> </tr> <tr> <td>QS3</td> <td>100%</td> <td>20min</td> <td>30min</td> <td>10%</td> <td>Disable</td> <td>Hs</td> </tr> </tbody> </table> <p>Note: Detection area / Hold time / Stand-by period / Stand-by dim level / Daylight sensor can be adjusted by pressing the corresponding button. The latest setting will stay valid.</p>	Scene Options	Detection Area	Hold Time	Stand-by period	Stand-by dim level	Daylight Sensor	Induction model	QS1	100%	5min	10min	10%	30Lux	Hs	QS2	100%	10min	30min	10%	Disable	Hs	QS3	100%	20min	30min	10%	Disable	Hs
Scene Options	Detection Area	Hold Time	Stand-by period	Stand-by dim level	Daylight Sensor	Induction model																								
QS1	100%	5min	10min	10%	30Lux	Hs																								
QS2	100%	10min	30min	10%	Disable	Hs																								
QS3	100%	20min	30min	10%	Disable	Hs																								
	TEST 2S	Press the "TEST 2S" button can enter the test mode any time. At the mode, the sensor parameters are as below: Detection Area is 100%, Hold Time is 5s, Stand-by Dim Level is 10%, Stand-by Period is 0s, daylight sensor disable. This function only for testing. Quit the mode by pressing "RESET" or any other function buttons.																												
	HS LS	Press "HS" button to set the detection area to be high sensitive. Press "LS" button to set the detection area to be low sensitive. The adjustment bases on the "Detection Area" parameter you set.																												
	Daylight Sensor	Set up daylight threshold: 5Lux/15Lux/30Lux/50Lux/100Lux/150Lux/ Disable.																												
	Stand-by period	Set up stand-by time: 0S/10S/1min/3min/5min/10min/30min/+ ∞																												
	Hold time	Set up hold time: 5S/30S/1min/3min/5min/10min/20min/30min																												
	Stand-by dim level	Set up stand-by dim level: 10%/20%/30%/50%																												
	Detection Area	Set up detection area: 25%/50%/75%/100%																												
	Remote Distance	Toggle button can set the remote distance of remote control and sensor.																												

MICROWAVE DIMMING SENSOR SETTING

Sensor data can be precisely set for each specific application by a remote controller which need to be bought separately.

Detection area

Detection area can be reduced by selecting the combination on the remote controller to fit precisely each application.

Optional Setting: 100%/75%/50%/25%

Default Setting: 100%

Hold time

Refers to the time period the lamp remains at 100% illumination after no motion detected.

Optional Setting: 5S/30S/1min/3min/5min/10min/20min/30min

Default Setting: 20min

Stand-by period

Refers to the time period the lamp remains at a low light level before it completely switches off in the long absence of people. When set to “+∞” mode, the low light is maintained until motion is detected.

Optional Setting: 0S/10S/1min/3min/5min/10min/30min/+∞

Default Setting: +∞

Notes: If just need ON/OFF function, please set the stand-by period in “0S” mode by the remote controller.

Daylight sensor

The sensor can be set to only allow the lamp to illuminate below a defined ambient brightness threshold. When set to Disable mode, the daylight sensor will switch on the lamp when motion is detected regardless of ambient light level. 50lux, 30lux: twilight operation, 10lux, 5lux: darkness operation only. Note that daylight sensor is active only when lamp totally switches off.

Optional Setting: 5lux/15lux/30lux/50lux/100lux/150lux/Disable

Default Setting: Disable

Stand-by dimming level

The low light level you would like to have after the hold time in the long absence of people.

Optional Setting: 10%/20%/30%/50%

Default Setting: 50%

APPLICATION NOTICE

- 1) The sensor should be installed by a professional electrician. Please turn off the power before installing, wiring, changing the setting of the DIP switch.
- 2) The sensor which installed in the plastic and glass lampshade will reduce the sensitivity. For every 3mm increase in thickness, the sensitivity will be reduced by 20%.
- 3) The dimming performance could be different from different 0/1-10v drivers.
- 4) The light sensitivity threshold is in a sunny environment, no shadow and ambient light diffuse reflection. Ambient lux level could be different in different environment, weather, climate, time-of-day and season.
- 5) The parameters of the sensor may need to be reconfigured in different installation environments. Please refer to the following instructions or contact the manufacturer.
- 6) Sensor could be triggered by wind and rain, as well as the moving objects nearby, if apply outdoor.
- 7) The mounting height is no more than 4m, proper mounting height is 3m; the distance between any inductive sensors should be greater than 3m.
- 8) Do not place the sensor close to high-density objects such as metal, glass, concrete walls, etc, false triggering could happen. When the sensor is installed in a metal lamp, metal reflective surface, or a narrow enclosed environment, the microwave will be reflected repeatedly and cause false triggering. Please reduce the sensitivity or contact the manufacturer for technical support.
- 9) Please ensure that there are no moving signals around the sensor, such as fan, DC motor, sewer pipe, air outlet, etc., the sensor may generate false trigger.
- 10) Due to continuous improvement, the contents of this instruction could be changed without prior notice

Ref#: 202201212