



ABOVE ALL

www.AboveAllLighting.com

V-LINE WALL PACK



ABOVE ALL: 1501 Industrial Way N. Toms River, NJ 08755

Tel: 866-222-8866

Email : info@aboveallighting.com

Inspiration Design

V-Line born in combination of sport car



V Sharp Design





New Era For Wall Pack

Better Lighting, Better Life.

Performance

High Efficiency & DLC Premium listed
88% energy saving than traditional wall
pack

Design

Architectural Design
Down & Up light option

Longevity

10 year warranty
L70 Life reach
105,000 hrs@25°C

Feature

Efficient design separates the driver from the LEDs for optimal heat sinking



Patented Air Cooling

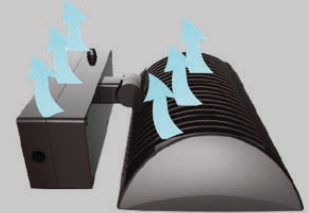

High quality die cast housing



Durable chip



Aadjustable head

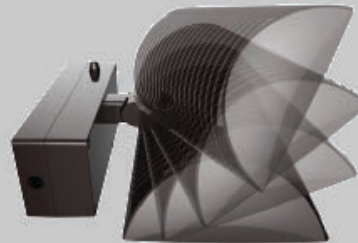

Dimensions

Without EBU and Motion Sensor

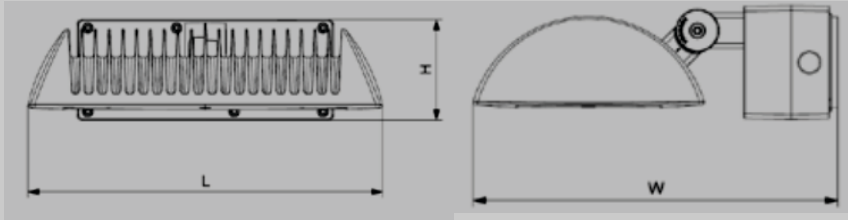

26W & 38W

Length: 10.12"

Width: 9.86"

Height: 4.69"

Max. Weight: 8.8 lbs

52W, 80W, 100W & 120W

Length: 15.32"

Width: 13.78"

Height: 4.4"

Max. Weight: 17 lbs

With EBU and Motion Sensor

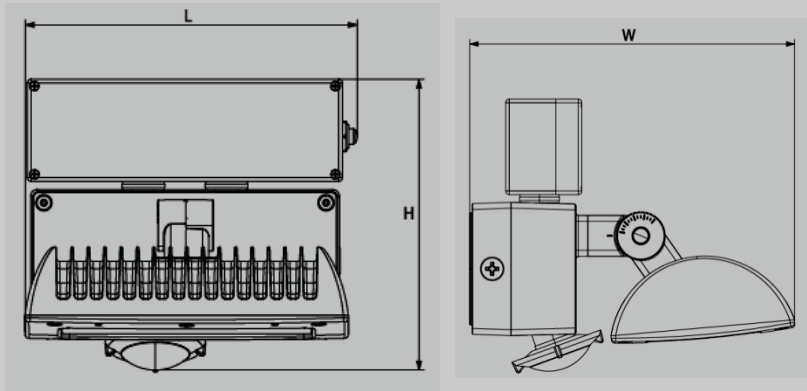

26W & 38W

Length: 10.35"

Width: 10.83"

Height: 9.24"

Max. Weight: 11.92 lbs

Photometry

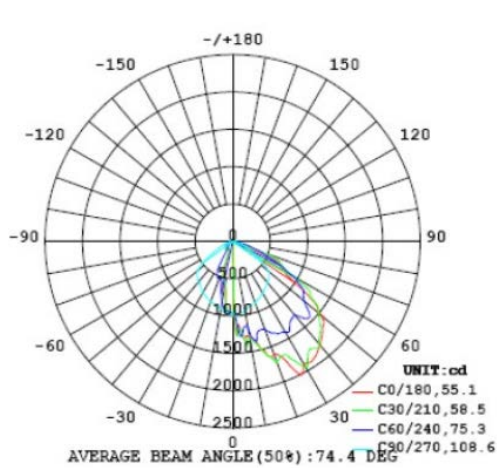

26W

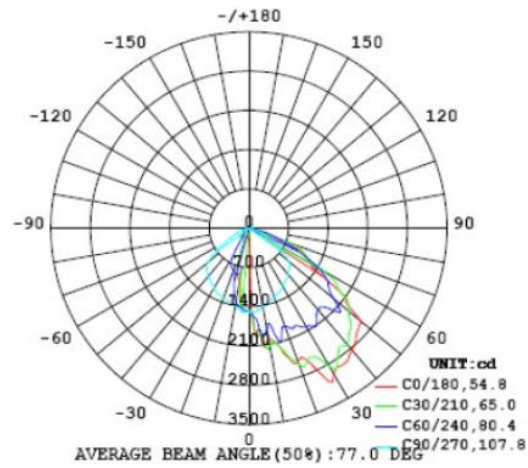

38W

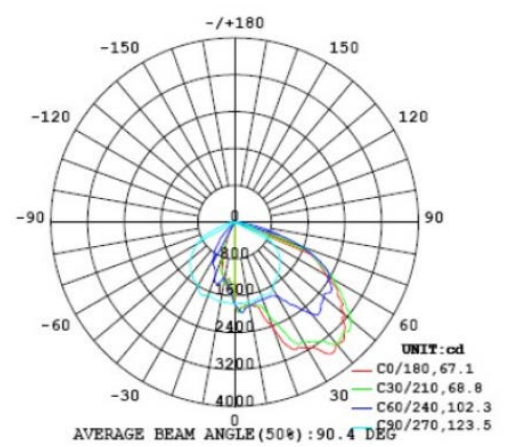

52W

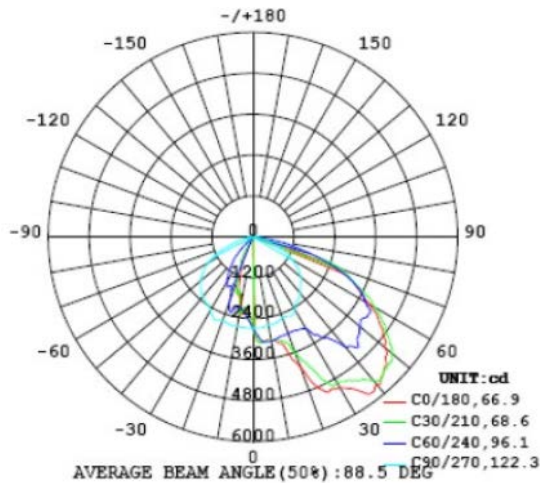

80W

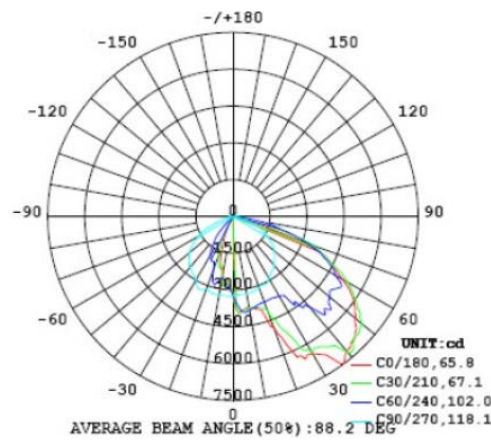

100W

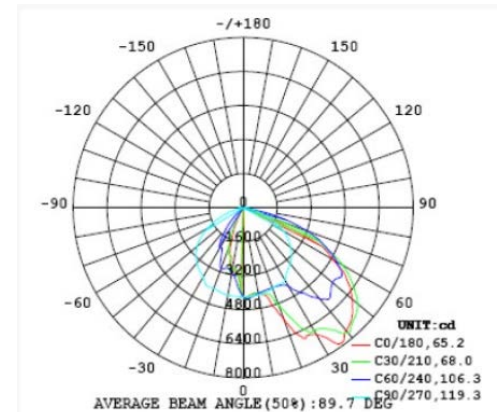

120W

Compliance & Standard

DLC 4.2 **Premium**



IP 65 Rated



10 Years
Warranty



ETL Wet
Location Listed



RoHS
Compliant



Meet's T24
Requirements



Control Parts

- Photo control optional for all watts
- Integrated motion sensor control optional(Only for 26W & 38W)
- Emergency battery backup optional(Only for 26W & 38W)

Model No.	Input Voltage(V)	Wattage(W)	Lumens (lm)	Control
WL26504-PC	120	26	3060	Photocell
WL38504-PC	120	38	4960	Photocell
WL52504-PC	120	52	6548	Photocell
WL70504-PC	120	80	10166	Photocell
WL100504-PC	120	100	12560	Photocell
WL120504-PC	120	120	14400	Photocell
WL26501-MS-L3B	120-277	26	3060	Motion Sensor
WL38501-MS-L3B	120-277	38	4960	Motion Sensor
WL26501-EBU6	120-277	26	3060	Battery backup
WL38501-EBU6	120-277	38	4960	Battery backup

*For other CCTs or lens type, please visit our spec on website for more details



With Motion Sensor



With Battery backup



With Photocell

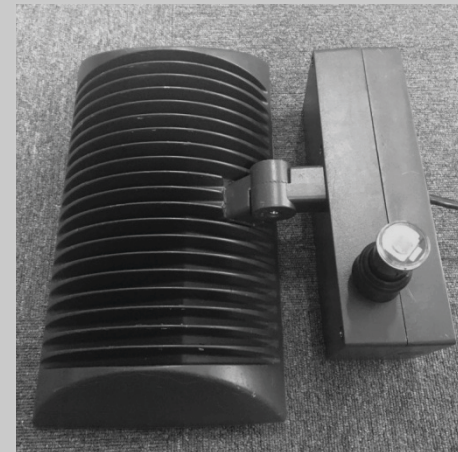

With Photocell(For 100W and 120W)

Application



CONSTRUCTION & MATERIALS

- Housing is all aluminum construction
- Terminal block for power input suitable for 18 AWG wire Luminaire sides are rugged die cast aluminum with integral, weather tight LED driver compartments and high performance heat sinks
- Surface-mount directly to a vertical or horizontal surface with direct included mount bracket

ELECTRICAL SYSTEM

- Input Voltage: 120-277V/ 120V/ 277V/ 347V/ 480V
- 50/60Hz
- Class 2 drivers
- Minimum ambient -40°C, maximum ambient 40°C
- Power Factor: > 0.9 at 120V input
- Total Harmonic Distortion: < 20%
- 26W, 38W integral 2KV surge suppression protection standard
- 52W, 70W, 100W and 120W integral 4KV surge suppression protection standard

Why Choose Above All Lighting V-Line Wall Pack?



- Architecture design
- High Efficiency & DLC 4.2 Premium listed
- Designed to replace 150-400W MH luminaires while saving up to 88% in energy costs
- Heavy duty construction and IP65 rated
- Long lifespan



Opening A New Era of LED lighting Innovation